

Emballage

French for “packaging”

Volvo's unique packaging system

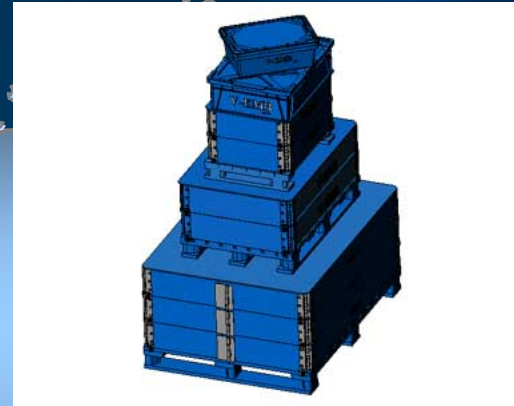
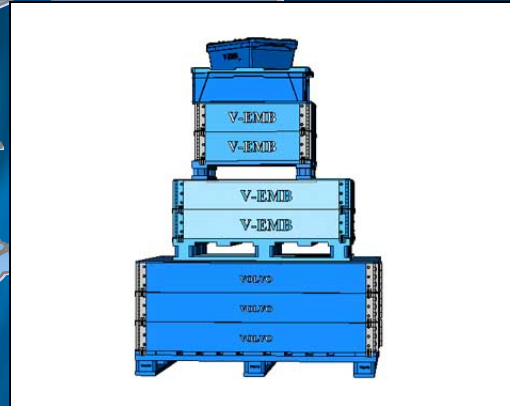

Volvo Packaging:
Plastic bins, crates, and pallets



More than 3,000,000 pieces of packaging supports
Our customer base worldwide



Volvo's unique packaging system

- ➔ Rent Packaging
- ➔ Reusable Packaging
- ➔ Packaging / Rack Design and Procurement
- ➔ Positioning / Stock Control
- ➔ Designed for your part

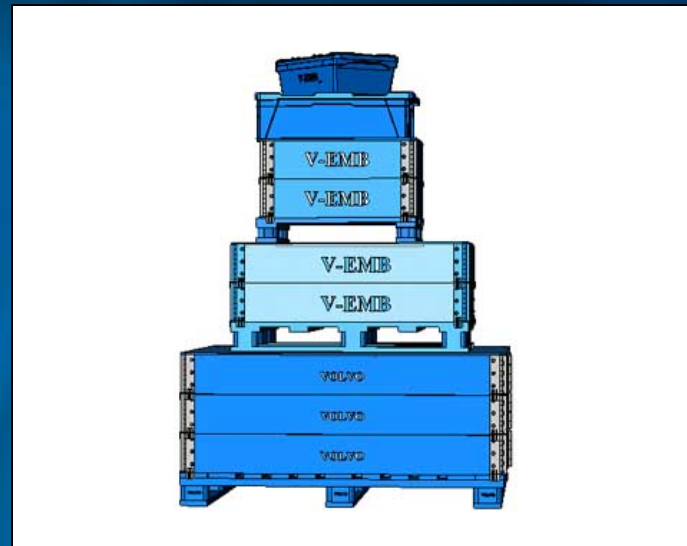

Volvo Packaging:
Plastic bins, crates, and pallets

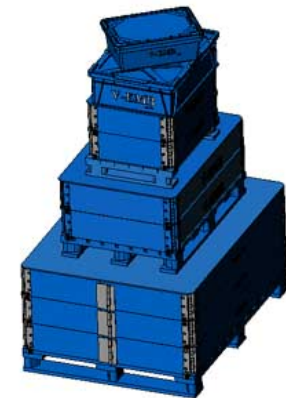

Plastic bins

Plastic Volvo Packaging bin fully loaded



Plastic Volvo Packaging with lid



Plastic bins are in various sizes and are stackable



From your dimensions...to our packaging.....perfectly

The Part

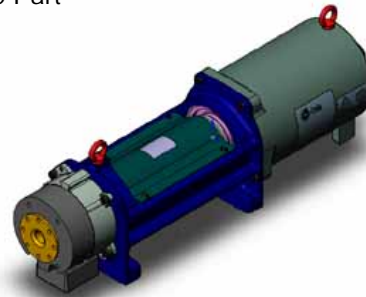

How the part will fit in Volvo Packaging

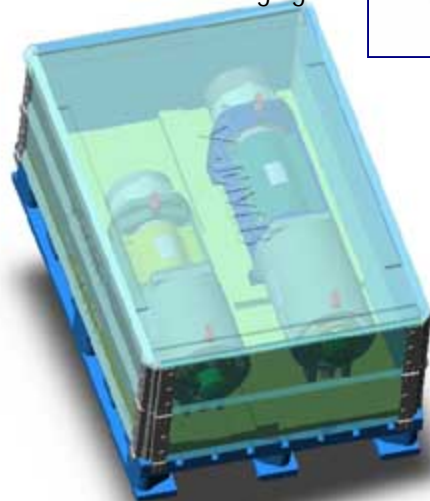

3D View of part inside packaging

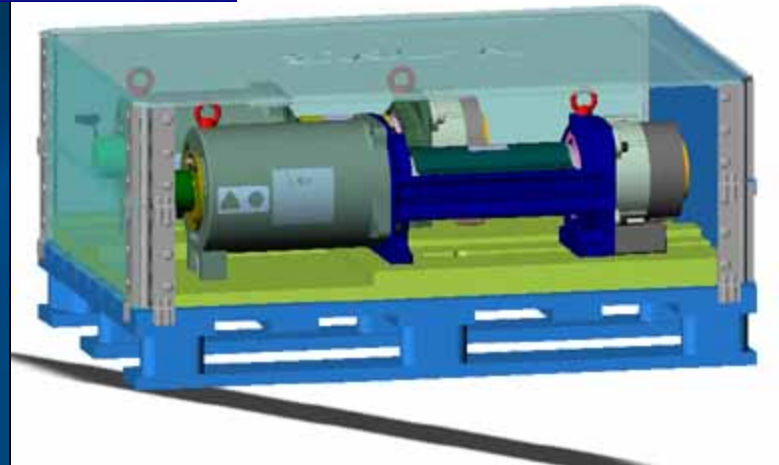

Or create a kit of parts

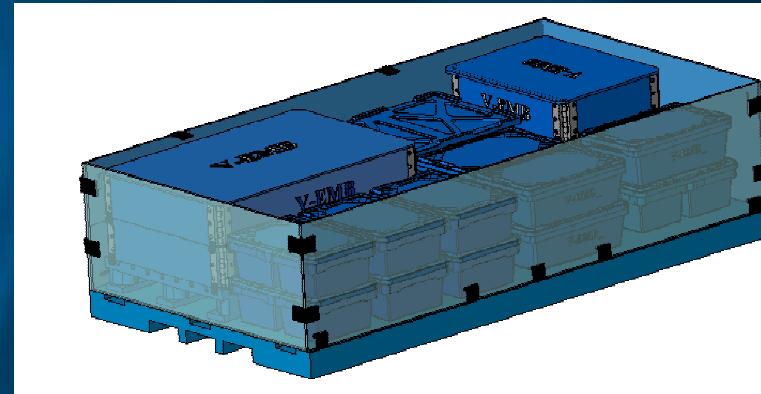
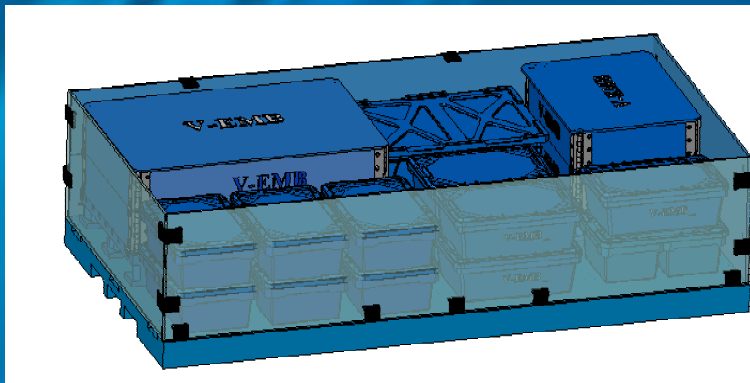

- Consistency in packaging
- High utilization of load
- Goods are free from damage
- Returnable

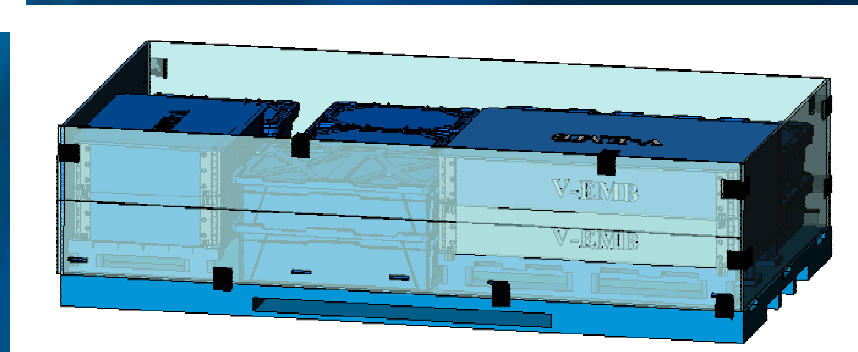

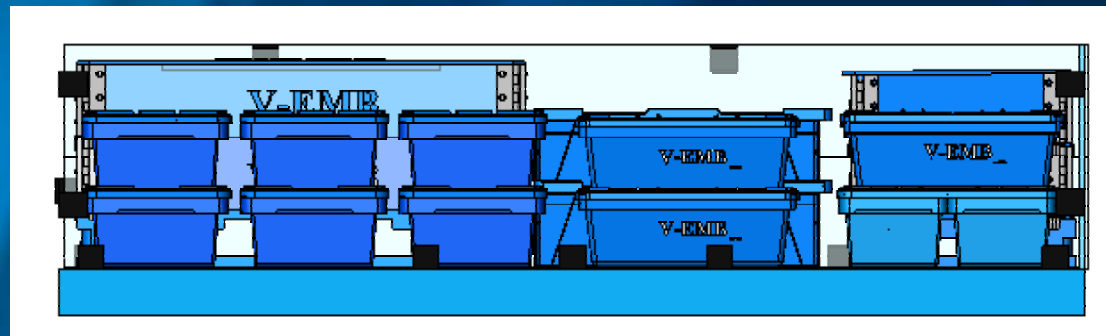
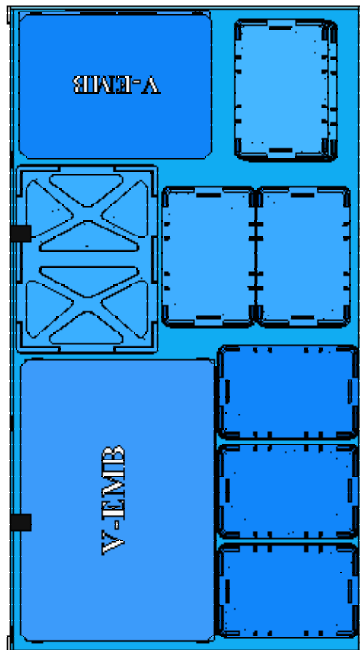
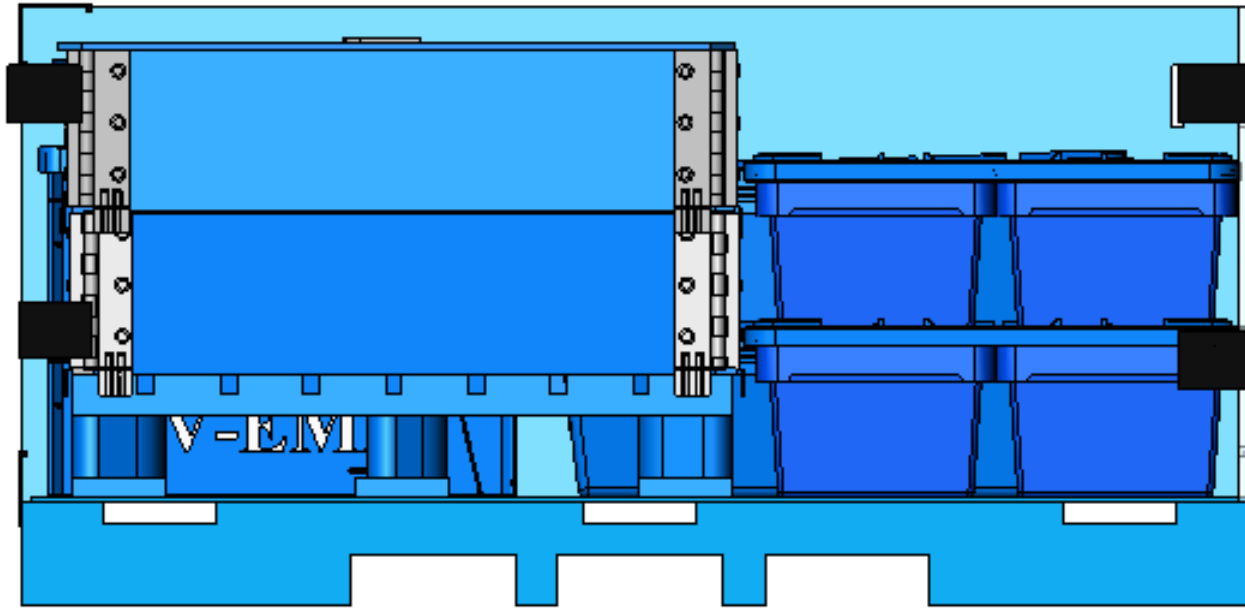

Large or small items? Unique size? No problem

Racks to move truck cabs

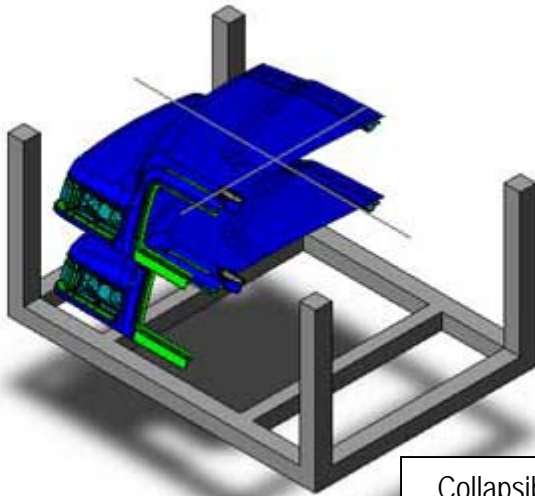

Shrink wrapped packaging

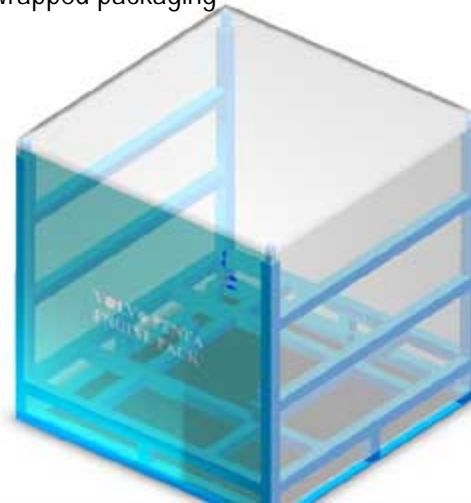

Collapsible rack for skid steer bucket (VCE)

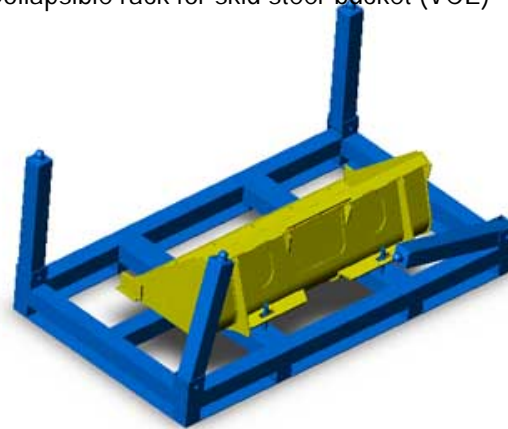

Parts arrive directly to factory for one move to use point...or to a hub for consolidation/deconsolidation/sequencing



Parts for production
Use point in
Volvo packaging

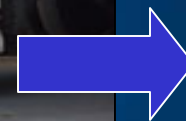

Volvo Logistics Hub, Dublin VA



Lost opportunity? Extra Freight? Damage?



Trailer loaded with combination of Volvo packaging and
10 Wood crates with shrink wrap

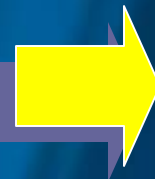

Trailer loaded with Volvo packaging fully utilizes trailer

VOLVO

Collapsed to be be recycled in the system



Volvo Packaging broken down in factory



Volvo Packaging is sent to Depot for repair and Re-deployment

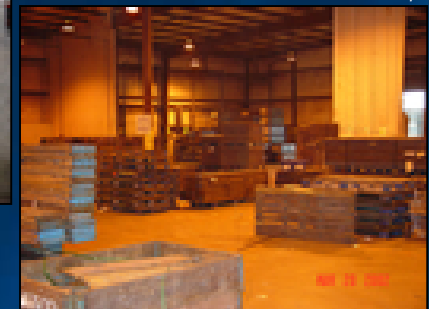

Volvo Packaging hub
Pulaski, VA

